

Verandazonwering

Sorrento

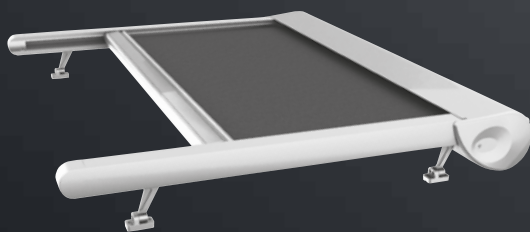

Een perfecte aanvulling op de pergola is de Sorrento zonwering, die perfect past bij de trend van dakbedekking pergola's en terrassen.

De Sorrento wordt gekenmerkt door solide afwerking van de beste aluminiumlegeringen, een harmonieuze en ergonomische vorm en gemakken in het dagelijks gebruik.

Sorrento GRANDE

Sorrento Grande kan op twee manieren worden gemonteerd, op het dak en onder het dak.

Sorrento Grande – algemene kenmerken

Sorrento GRANDE

Sorrento Grande kan op twee manieren worden gemonteerd, op het dak en onder het dak.

- universeel gebruik (installatie op het dak of onder het dak)
- 100% productie in Europa
- Maximale afmetingen 5,0 x 6,0 m of 6,0 x 5,0 m

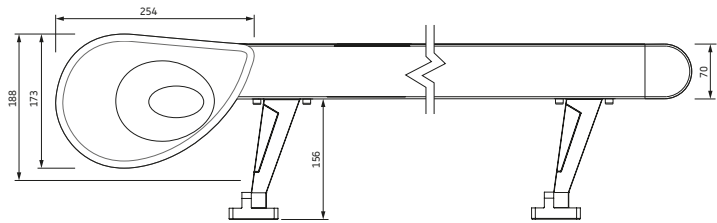

Montage

opbouw montage (muursteunen zijn optioneel)

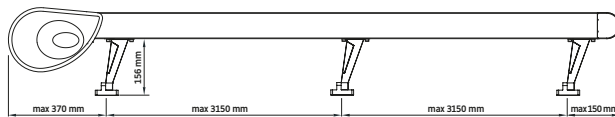

inbouw montage (muursteunen zijn vereist en worden toegevoegd aan de prijs)

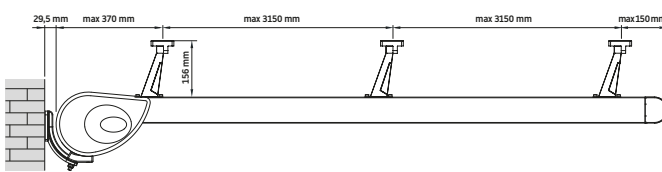

Muursteunen

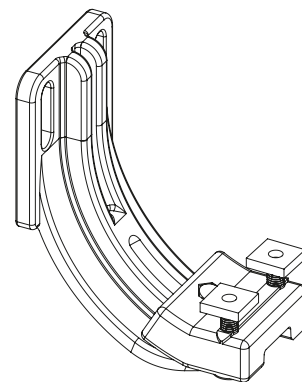

Standaard kleuren



RAL 9001
Crémewit satine



RAL 7s16
Antracietgrijs
structuurlak



RAL 7s24
Antraciet
structuurlak

Koppeling

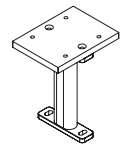
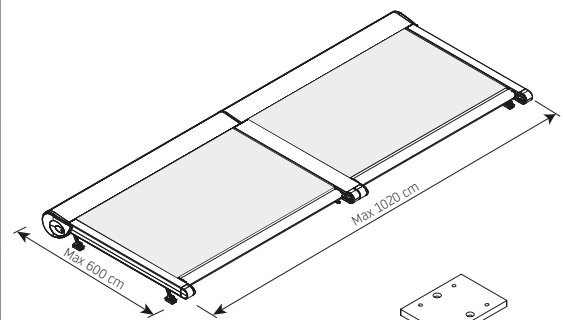

Onderlat

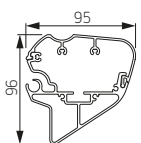

Geleiders

